

www.ornetlifts.com



Taking Technology
to the next level





**Committed to
Creating
Comfortable
Travel Space**

www.ornetlifts.com

Quality and Service to
Improve Performance



Company Profile

ORNET Lifts is acknowledged as one of the leading companies based in Ahmedabad, Gujarat. We are globally acknowledged Manufacturer, Supplier and Exporter of extremely efficient Lifts.

Since the establishment in 2013, we have shown a remarkable growth. Director of the company, Mr. Surendra Mishra has more than 13 years of experience in the industry.

Infrastructure

We have two well developed factories. Our state of the art manufacturing unit is under the supervision of experts.

Our manufacturing unit is fully equipped with the latest machinery. The computer aided manufacturing unit enables us to have a high production capacity of 450 lifts per year.



Passenger Elevator



Capsule Elevator



Hospital Elevator



Goods Elevator



Car Parking Elevator



Dumbwaiter



Home Elevator



MRL Elevator



Hydraulic Elevator

Passenger Elevator

Quality, Simplicity, Elegance

Manual Door

Manual Passenger Elevators for economically suited all type of Residential & Commercial Buildings depending upon the shaft size with speed / amenities up to choice of owners.

Capacity 04 to 30 Passenger



Various options are available :

Speed	0.70 to 1.mt/ps
Capacity	04 to 30 Passenger
Car Finish	MS Powder Coated Car. Stainless Steel Hair line Finish Car. Steel Designed & Steel Hair line Finish Car. Steel Mirror & Stainless Steel Hair line Finish Car.
Doors Finish	M.S Swing Manual Doors, M.S Collapsible Manual Doors Wooden Swing Manual Doors
Switch Panels Button	Surface Micro Electro Button
Switch Panels Display	Seven Segment Digital LED Display. Digital Dot Matrix Display.

Car Calling





Glass Swing Door



M.S. Telescopic Door



COP

LOP

Special Features

- Based on VVVF device technology.
- Smooth & quiet functioning.
- Compact & Trim.
- Available in both geared and gearless.
- Low Cost of Ownership - Reduced energy cost & maintenance costs.



Imperforates Door



Collapsible Door

Flooring



Passenger Elevator

Our Auto door elevators are also durable by design and accurate by technology.

We have a wide range of these elevators which are most reliable and designed to suit every construction requirement and provide best vertical transportation solutions, with trouble free performance and low maintenance cost. These elevators are a perfect blend of all good features of various types of elevators. These have excellent record of customer satisfaction.

Capacity 06 to 20 Passenger

Automatic Door



Various options are available :

Speed	0.70 to 1.5 mt/ps
Capacity	06 to 20 passenger
Car Finish	MS Powder Coated Car. Stainless Steel Hair line Finish Car. Steel Designed & Steel Hair line Finish Car. Steel Mirror & Stainless Steel Hair line Finish Car. Titanium Gold Designed with Stainless Steel Finish Car.
Type of Door	• Center-Opening Auto Door. • Telescopic Auto Door.
Doors Finish	MS Powder Coated Auto Door. Stainless Steel Hair line Finish Auto Door. Stainless Steel Designed Finish Auto Door. Titanium Gold Designed Finish Auto Door. Glass With Stainless Steel Framed Finish Auto Door.
Switch Panels Button	• Surface Micro Electro Button. • Touch Button.
Switch Panels Display	• Seven Segment Digital LED Display. • Digital Dot Matrix Display. • LCD Display.

Ceiling

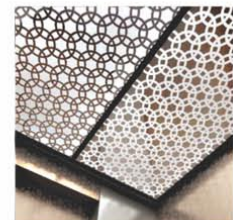



Door Header



Multi-ray Entrance Protection System

- Operating by 94 crossed infrared beams
- Enclosed power supply unit
- Detecting area 20-1840 mm
- Beeping on Passing by Detecting Range

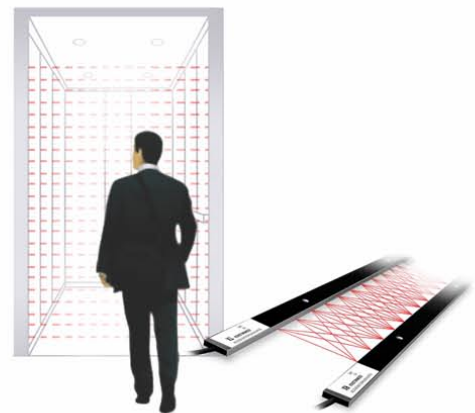

Handrail

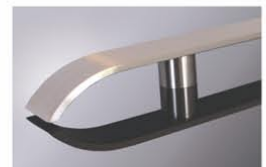

Capsule Elevator

The Stylish Way to Brand Your Elevator

Panoramic

- Capsule elevators are inspired with creative flair to suit your particular idea.
- Capsule elevators give an upscale, attractive feel to offices, shopping malls, multiplexes and other prestigious buildings.
- They are offered in different sizes, specifications, shapes and capacity according to the requirements of our clients.

Capacity 10 to 16 Passenger



Features of the Capsule Elevators

Made from S.S. / M.S. with vision panel.
Color-Powder coated, Elegant looks, Light in weight and variable speed.
Controller Full Proof to voltage (PLC or Solid state) with fully collective - selective system.
AC VVVF drive for jerk free operation & for variable speed.
Overload indication and Auto Door announcing system.
Avail Inverter facility for single base at time of Power failure.
Push Button Luminous type highly attractive as well as durable.
Facility Floor Position Indication at the floors as well as in cabin.

There is a variety of forms to meet different needs.

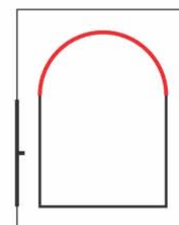

Semi-circular Type

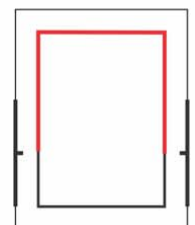

Square Type

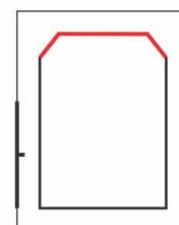

Octagonal Type

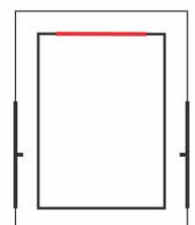

Future Prospects



Square Glass Cabin



Five Side Glass Cabin



LOP & COP

Feature :

- Attractive Looks.
- Unique Features.
- Transparent.
- Beautiful Designs.

Application :

- Shopping Malls.
- Hotels.
- Offices.
- Multiplexes.



Powder Coted Round Glass Cabin



S.S. Round Glass Cabin

Hospital Elevator

Safe Preparation

Install service is the prerequisite of healthcare industries. By offering excellent services, ORNET has achieved the paramount place in the service industries.

ORNET bed and stretcher elevators series follow persistent compassionate thinking, By applying destination control and group control mechanism, ORNET fulfills the intellectual elevator travel and reduces the patient's waiting period to minimum extent.

Capacity 15 to 26 Passenger



Safety Door Edge (SDE)

A mechanical safety device with a micro-switch reverses closing doors if there is physical contact with a passenger or an object.



Various options are available :

Ceiling	Stainless Steel Ceiling Square LED Light Blower fan
Car Operating Panel	Stainless Steel Luminous Buttons (Square Type) with LCD Floor Positioning Indicator
Car Enclosure	S.S. Hairline Finish Car
Flooring	PVC / Chequered Plate
Car Door	S.S. Hairline Finish Door



Goods Elevator



For transporting goods vertically requires meticulously designed elevators. Elevator designing requires painstaking efforts to match various needs. There are many criteria to be considered carefully while designing goods elevator like, size, goods to be transported, method of handling and the ambiance in which lift operates. ORNET has designed and supply array of products to suffice the need of various industries.

At ORNET, we assist you in all ways and means helping you to achieve the right vertical transportation.

500 to 4000 kg Load Capacity



Sturdy and Durable

Cabin is made of highly intensified shaped materials, able to carry various kinds of cargoes.

Accurate Leveling

The accuracy of leveling can be controlled within a scope of several millimeters.

Large Door Width

Multiple folded cabin door structure is employed to reach the max width, Which facilitates the entry of large cargos.



Light curtain protection

ORNET intelligent freight elevator applies high intensity section material to make the elevator car. It implements special reinforced design to car chassis. The products are more durable with little aging after long-term use.

Safe and reliable structure and high intensity

High strength sheet bending & forming technology ensures firm and durable car. In addition, optional specially - designed anti - collision guardrail carries out multiple protection to elevator car.

Durable in use stable in operation

ORNET intelligent freight elevator creates famous brand by small advantages. The product leveling accuracy can be controlled with in mm level range.

Car Elevator

In ORNET, Car elevator are immaculately designed to carry the load and spaciousness to accommodate the various size of cars available in the market. Precision in design and safety are the paramount and prerequisite while designing car elevators. ORNET car elevators come with both, single side and two side opening option. Please ask ORNET sales person for various optional features for car elevators.

500 to 3000 kg Load Capacity



Technical Data :	
Description	Vertical Transportation for Cars/ LMVs
Segment	Industrial applications & Car Parks
Max. travel (m)	100 (Solutions available for higher travel)
Max. load (kg)	500 - 3000 Kg (Solutions available for higher capacities)
Max. speed (m/s)	0.5 mps (Solutions available for other speeds)
Max. group size	Duplex

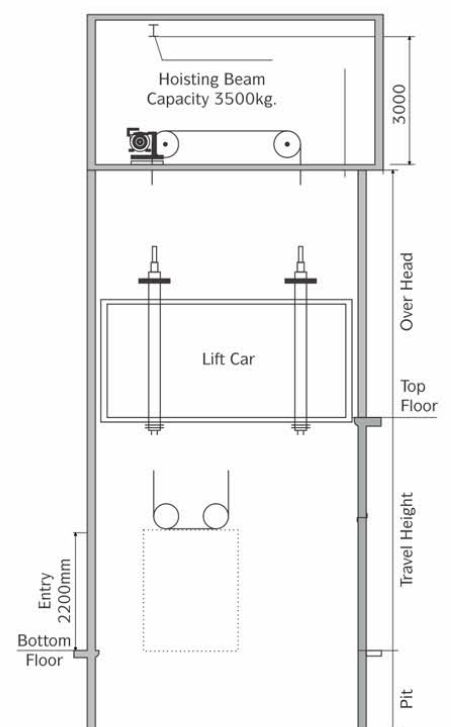
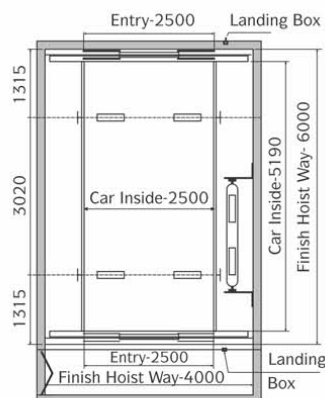

Two Car Parking System



Characteristics of the System :

- Saves Land area and take full use of the current space to raise the number of parking cars.
- The structure is simple, united and easy for operation
- Suitable for Car Models - Sedan for all levels & SUV for only ground level.
- Adapted Places: Apartments, yards & lower height of basements, IT parks, Hotels. It can be used both indoor & outdoor.



Electric Scissor Car Lift

A New Level of Parking Freedom

Technical Specification	
Product Description - 2 Pole Hydraulic Car Stacker (1+1)	
Model	OSR - 001
Stall Length	4.0 Meter
Stall Width	2.2 Meter
Pole Height	3.4 Meter
Max Travailing Height	2.0 Meter
Rated Lifting Capacity	2000 kg
Rated Speed	Up 0.04 M/S, Down 0.05 M/S
Operation	Hydraulic Power Pack with 2HP Motor, One Cylinder with Control Panel (Per Unit) Operated by Key
Electrical Requirement	3-Phase 415V 50Hz / 1-Phase 220V

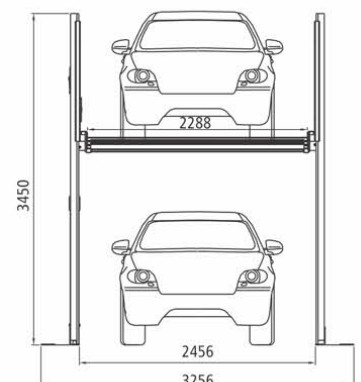
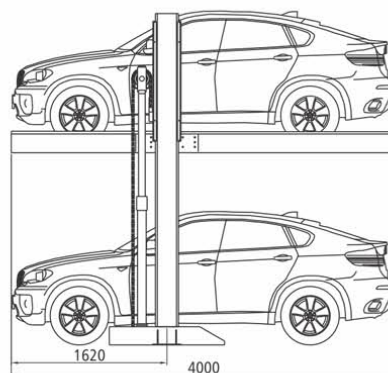

Dumb Waiter



Safe, Comfortable, Reliable

ORNET Dumbwaiter provides convenience to hospital and hotel business. Which significantly saves time and energy. These elevators widely applied to hotels, hospitals, restaurants, banks, malls and various places for the enhancement of the services they provide. Dumbwaiter widely used in hospitals for littering bio - medical waste. ORNET has provided dumbwaiters to many prestigious government and non government medical institutes and hospitals.



100 to 250 kg Load Capacity



Dumbwaiter
Capacity 100 kg / 250 kg

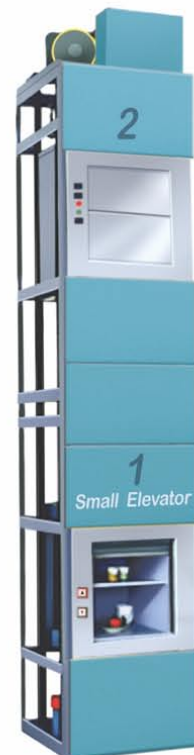

Various options are available :

Speed	0.15 to 0.30 mt / ps
Capacity	100 kg to 250 kg
Car Finish	MS Powder Coated Finish Car. Stainless Steel Hair line Finish Car.
Doors Finish	M.S Collapsible Manual Doors. MS Powder Coated Manual Door. Stainless Steel Finish Swing Manual Door. MS Powder Coated Manual Door. Stainless Steel Finish By Parting Manual Door.
Switch Panels Button	Surface Micro Electro Button
Switch Panels Display	Seven Segment Digital LED Display. Digital Dot Matrix Display.

Home Elevator



Residential

ORNET home elevator are designed to enhance the convenience at your residence, yet it is space saving, highly elegant and perfectly blends with contemporary architecture.

Balancing our customer demands for aesthetic ambience, technology integration & user satisfaction is what we do the best.

Various designing options for car & car top lighting can be selected as indicated.



Capacity 03 to 04 Passenger

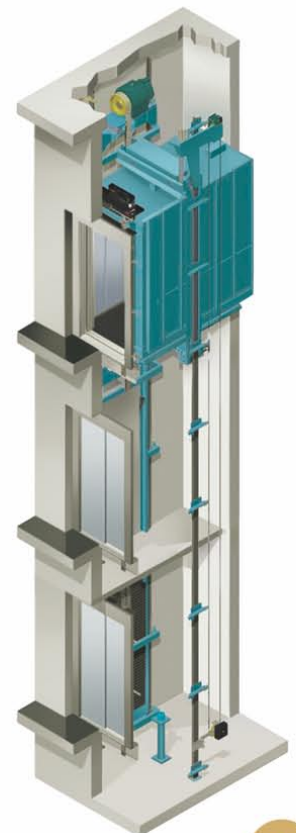

Specification

RPM	120	Pulley Dia.	100 mm
Frequency	12 Hz.	Rope Dia.	4 mm
Voltage	230 VAC	No. of Ropes	4
kW / Hp	0.75 / 1	Lifting Capacity	300 kg
Weight	70 kg.	Lift Speed	0.32 m/s
Brake	Pick-up : 220 VDC	Max. Travel	15 Mts.
Voltage	Holding : 110 VDC	Starts / Day	100

Features :

- Wide range of designs to suit Your home / bungalow.
- Noiseless and easy to install.
- Requires minimal space.
- Safe and reliable for elderly People and children at home.

All Dimension are in mm.
This is General Data, it may be changed without notice.

MRL Elevator

It reduces the building expense and saves the construction cost too

ORNET Machine Roomless Elevator gathers together the excellent ORNET lift system and the research fruits of the architectural adaptability. It has been independently researched into and developed ORNET company.

It adopts the mature control technology and the advanced design concepts that lead the trend with a combination of the superior performance permanent magnet synchronous and gearless drive system. It completely merges with the constructions to fully hoist the building aesthetics and values. It has very high cost performance advantages ORNET Machine Roomless Elevator is just like the eyes of the architecture. It thoroughly shows the construction characteristics.

Capacity 04 to 15 Passenger

Machine Roomless Elevator



It saves 25% of total elevator equipment area. It reduce 40% of space occupation.

Advantages:

- ▶ Latest technology in the world
- ▶ Smooth and swift in operations
- ▶ Flexible to all building designs
- ▶ Consumes less electricity
- ▶ Safe and reliable

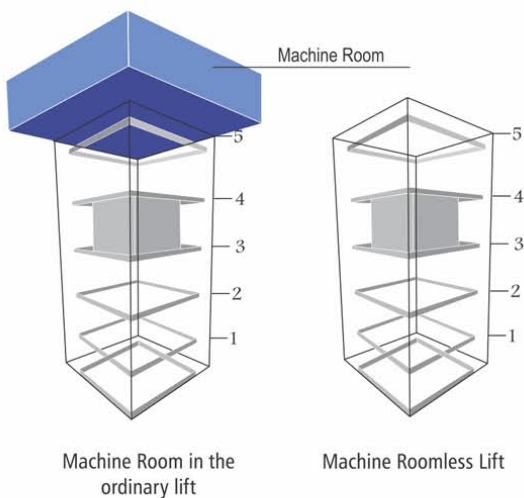
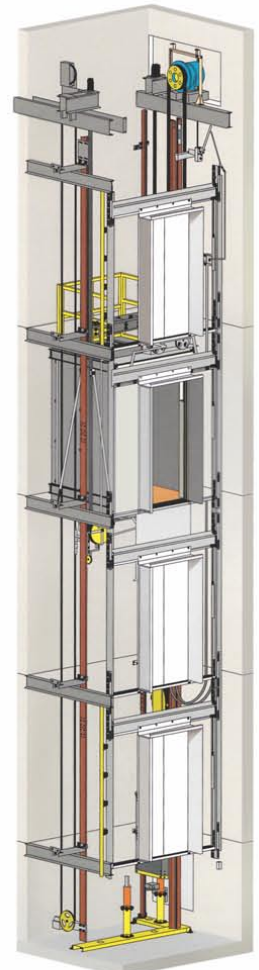

Energy Saving



Steady Running



Sturdy and Durable



Green and Maintenance-Free

Hydraulic Elevator

For Low Rise



Hydraulic Passenger / Goods Elevators Manual / Auto door for Residential, Commercial, Hotel, Clubs, Bungalows & Industrial buildings depending upon the shaft size & convenient machine room less movement of men, material & vehicles. With speed / amenities up to the choice of owners.



Capacity 03 to 20 Passenger



Cylinder



Power Pack Unit



Pulley



EV-100

Various options are available :

Speed	0.5 to 1.0 mt / ps
Capacity	6 to 12 passenger
Car Finish	MS Powder Coated Car. Steel Designed & Steel Hair line Finish Car. Steel Mirror & Stainless Steel Finish Car. Titanium Gold Designed Car.
Type of Door	• Auto Door. • Manual Doors.
Doors Finish	M.S Collapsible Manual Doors. MS Powder Coated Finish Auto Door. Stainless Steel Designed Finish Auto Door. Glass With Stainless Steel Auto Door.
Switch Panels Button	• Surface Micro Electro Button. • Touch Button.
Switch Panels Display	• Seven Segment Digital LED Display. • Digital Dot Matrix Display. • LCD Display.

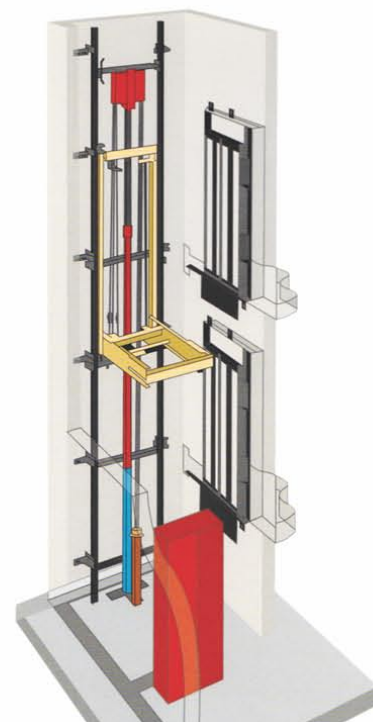

Automatic Door



Gold Mirror Finish Center Opening
Big Vision Glass Door



S.S. Center Opening Door



Designer Center Opening Door



Gold Finish
Telescopic Autodoor



Gold Finish
Center Opening Autodoor



Big Vision Glass Autodoor



4 Part Center Opening
Telescopic Autodoor

Manual Door



Collapsible Manual Swing Door



M.S. Manual Swing Door



Manual Sliding Door



Manual Telescopic Glass Door



IFD Manual Door



Full Glass Manual Swing Door



Small Vision M.S. Swing Door

Cabin Designs



OL-01



OL-02



OL-03



OL-04



OL-05



OL-06



OL-07



OL-08



OL-09



OL-10



OL-11



OL-12

Cabin Designs



0113



0L-14



0L-15



0L-16

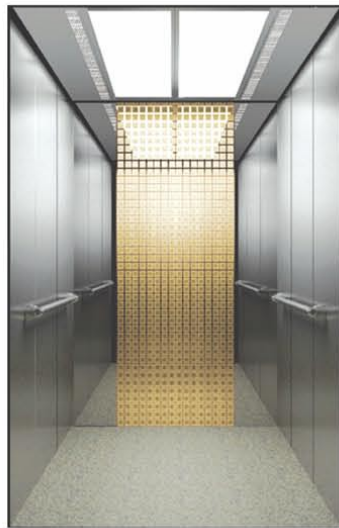

0L-17



0L-18



0L-19

Car Operating System



PS-01C

PS-01L

PO-01C

PO-01L



240 X 128 GLCD Monochrome



16 X 16 Two Digit Dot Matrix Display



TFT Color Display 4.3"



PPO-01C



VTP-01C



VTP-01L



VT-05C



VT-02L

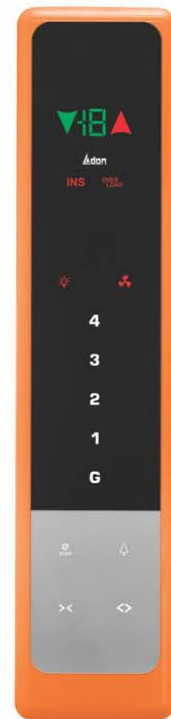

ET-02C



ET-02L

Elevator Machine

Machines are specially designed for various application such as speed and capacity with rigid & rugged reliability, smooth trouble free operation. Use standard worm and worm gears with taper roller bearings and thrust bearing in machine for maximum load carrying capacity. The perfect lubrication system gives longer life and smooth operation. The machine are mounted on special type of rubbers which have extra ordinary dumping capacity, due to this characteristic, the machine runs vibration free.

Geared Motor Unit



Heavy Duty Traction Machine

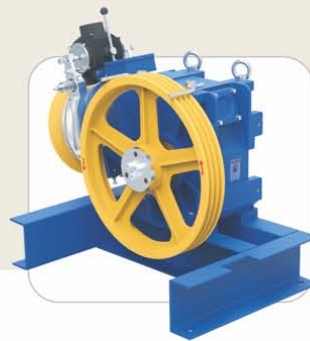

High Speed Traction M/c.



Upper Traction M/c.



Gearless Motor Unit

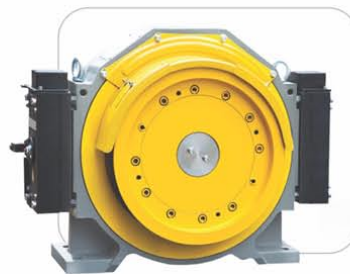

Gearless Machine



Mini Gearless Machine



Home Lift Single Phase Gearless Machine

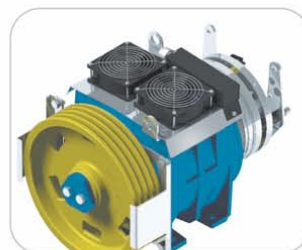

Gearless Machine



Gearless Machine

Controller & Drive



Energy-efficient and simple to use : our panels put you in over your elevator systems.

ORNET has been installing and servicing elevator for more than a decade.

ORNET bring Millennium Most advanced energy saving VVVF elevator system with highly with sophisticated Microprocessor based Pulse Width Modulation (PWM) Technology ORNET complete integrated VVVF control system ensures best return of Cost.



VVVF, ARD Microprocessor Control Panel



Microprocessor Controller



MRL Panel

V3F Drive



Feature Rich Elevators

ORNET ELEVATORS Passenger Elevators comes with many enviable features* ranges from 4-Pax to 26-Pax



Door Frames :

HIND ELEVATORS Lifts come with elegant door frames in Stainless Steel or Mild Steel finishes that gives strength as well as enlarged appearance.



Infrared Door Detector :

A full height curtain of infrared beams to prevent accidental closing of the door.



Auto Shut Off Car Light / Fan :

If there is no call for a specific period, the car lighting and ventilation Fan will automatically turn off to conserve energy.



Regenerative Converter :

For energy conservation, power generated by a traction machine can be used by other electrical systems in the building.



Over Load Indicator :

In case the lift is overloaded than its rated capacity an audible / visual signal turns on.



Supervisory Panel :

Each elevator status and operation can be remotely monitored and controlled through a panel installed in a building's supervisory room etc.



Automatic Rescue Device (ARD) :

Automatically takes the lift to the nearest level in case of power interruption, doors open to facilitate the safe evacuation of passengers.



VVVF Controllers :

The Variable Voltage Variable Frequency (VVVF) control ensures 50% energy savings. It also creates a super comfortable ride quality with jerk free starts and stops. Smooth acceleration and deceleration and no landing variations. In the long run, this prevents wear and tear of components which means less downtime and huge saving on spares.



Stainless Steel Buttons :

Sophisticated design buttons flush with backplate having Orange / Red illumination with engraved numbers. Highly temper resistance with / without braille markings.



VVVF Door Controller :

Silken smooth door movement. Advanced features like adjustable independent times for opening and closing. Slow nudging feature ideal for high traffic situations.



LCD / TFT Position Indicators :

The LCD or TFT display of Car operating panel shows the car position, travel direction and elevator status message.



Floor Annunciator :

Recorded voice with music announces the floor number on arrival.



Inter communication system :

A system which allows communication between passengers inside the car and the building personnel.



Extended Door Open Button :

When the button inside the car is pressed the doors will remain open longer to allow loading and unloading of baggage, a stretcher etc.



Fire Emergency Operation :

To enable fire service personnel to take over complete control over the elevator.



Car Arrival Chime :

Electronic chimes sound to indicate that Car has arrived floor (for duplex only)



Emergency Car Lighting :

Car Lighting which turns on immediately when power fails, providing a minimum level of lighting within the car.

*Please consult ORNET ELEVATORS representative / agent for details.

We are Technically Associated with



Service



The Most Extensive of
Elevator and Maintenance
Service in the Industry.



ornet lifts

Shed No. - 1, Shreenathji Estate, B/h. Sumel-7,
Panna Estate Road, Rakhial, Ahmedabad - 380023
(Gujarat) INDIA.

Phone : + 91 079 - 22776630

Mobile : + 91 9377506630

Email : info@ornetlifts.com, mishralifts@gmail.com

Website : www.ornetlifts.com

Branches :

Baroda, Gandhidham, Bhuj, Luchnow, Haridhwar, Gazhiabad